

outdoor  
special

**outdoor special**

# index

|                      |           |
|----------------------|-----------|
| The project          | 06        |
| <b>Green</b>         | <b>09</b> |
| <b>Furniture</b>     | <b>39</b> |
| <b>Water</b>         | <b>59</b> |
| Data sheets          | 71        |
| Summary of materials | 81        |
| Technical features   | 88        |



La proposition pour extérieurs de **Porcelaingres** s'enrichit de morceaux spéciaux et de nouveaux produits permettant de réaliser de nouvelles solutions non seulement pour les jardins, les piscines et les terrasses, mais aussi pour les espaces publics.

**Outdoor special** est un catalogue destiné aux architectes, aux designers et aux particuliers qui veulent créer des solutions uniques pour l'extérieur, car il vous permet de créer une continuité avec l'intérieur. A la possibilité de choisir le même sol entre l'intérieur et l'extérieur s'ajoute également celle de réaliser des éléments d'ameublement coordonnés.

Un large choix de couleurs, de finitions et de surfaces, y compris la pierre, le béton et le bois, conçus pour inspirer et garantir une liberté extrême de conception, grâce à la résistance et à la fiabilité du grès porcelainé technique en 20mm d'épaisseur.

La polyvalence de ce matériau offre donc la possibilité de réaliser des espaces extérieurs et urbains entièrement personnalisés en laissant place à la créativité individuelle et en s'adaptant aux différentes figures de style.

La propuesta para exteriores de **Porcelaingres** se enriquece con piezas especiales y nuevos productos que permiten crear innovadoras soluciones no solo para jardines, piscinas y terrazas, sino también para espacios públicos.

**Outdoor special** es un catálogo dirigido a arquitectos, proyectistas y particulares que quieren realizar soluciones únicas para exteriores, ya que permite crear una continuidad con los ambientes interiores. A la posibilidad de elegir la misma pavimentación para interiores y exteriores, se suma la de realizar elementos decorativos coordinados.

Una amplia gama de colores, acabados y superficies, que incluyen piedra, cemento y madera, pensados para inspirar y garantizar plena libertad de proyecto gracias a la resistencia y fiabilidad del gres porcelánico técnico de 20 mm de espesor.

La versatilidad de este material ofrece así la posibilidad de realizar espacios exteriores y urbanos completamente personalizados, dejando espacio a la creatividad individual y adaptándose a las distintas expresiones estilísticas.

La proposta outdoor di **Porcelaingres** si arricchisce con pezzi speciali e nuovi prodotti che permettono di realizzare nuove soluzioni non solo per giardini, piscine e terrazze, ma anche per gli spazi pubblici.

**Outdoor special** è un catalogo rivolto ad architetti, progettisti e privati che vogliono realizzare soluzioni uniche per esterni, perché permette di creare una continuità con gli ambienti interni. Alla possibilità di scegliere la medesima pavimentazione tra interno ed esterno si aggiunge inoltre quella di realizzare elementi di arredo coordinati.

Un'ampia scelta di colori di finiture e di superfici, che comprendono pietra, cemento e legno, pensati per ispirare e per garantire estrema libertà di progettazione, grazie alla resistenza e affidabilità del gres porcellanato tecnico in 20mm di spessore.

La versatilità di questo materiale offre dunque la possibilità di realizzare spazi outdoor e urbani interamente personalizzati lasciando spazio alla creatività individuale e adattandosi alle diverse cifre stilistiche.

The outdoor range by **Porcelaingres** has now been expanded with special pieces and new products that can help you craft new solutions not just for gardens, pools and terraces, but for public areas as well.

**Outdoor special** is a catalogue for architects, designers and private individuals who wish to craft unique outdoor solutions, as it can create continuity with indoor décor. In addition to choosing the same flooring for indoor and outdoor, there is also the option of creating matching furnishings.

A broad selection of colours, finishes and surfaces, including stone, concrete and wood, designed to inspire and provide full freedom of expression, thanks to the strength and reliability of 20 mm thick high-tech porcelain stoneware.

The versatility of this material thus offers the opportunity to create fully custom outdoor and urban areas, giving leeway to personal creativity and suited to the spectrum of individual styles.

Das Outdoor-Angebot von **Porcelaingres** wird mit Formteilen und neuen Produkten bereichert, dank denen man nicht nur für Gärten, Schwimmbecken und Terrassen, sondern auch in den öffentlichen Bereichen neue Lösungen schaffen kann.

**Outdoor special** ist ein Katalog, der an Architekten, Planer und Privatpersonen gerichtet ist, die einzigartige Lösungen für den Außenbereich fertigen möchten, der die Schaffung eines fließenden Übergangs zu den Innenbereichen ermöglicht. Neben der Möglichkeit, den gleichen Fußboden für innen und außen zu wählen, können verbindende Einrichtungselemente gefertigt werden.

Wir bieten ein breites Angebot an farblichen Ausführungen und Oberflächen wie etwa Stein, Zement und Holz, die gedacht sind, um dank ihrer Widerstandsfähigkeit und Verlässlichkeit des technischen Feinsteinzeugs in 20 mm Stärke eine extrem große Planungsfreiheit zu vermitteln und zu garantieren.

Die Vielseitigkeit dieses Materials, das sich an alle stilistischen Maßstäbe anpasst, bietet daher die Möglichkeit, Outdoor- und Stadtbereich mit einer ganz persönlichen Note zu gestalten, wobei der individuellen Kreativität freien Lauf gelassen wird.



GREEN



# Green

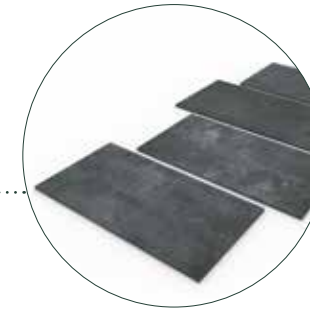
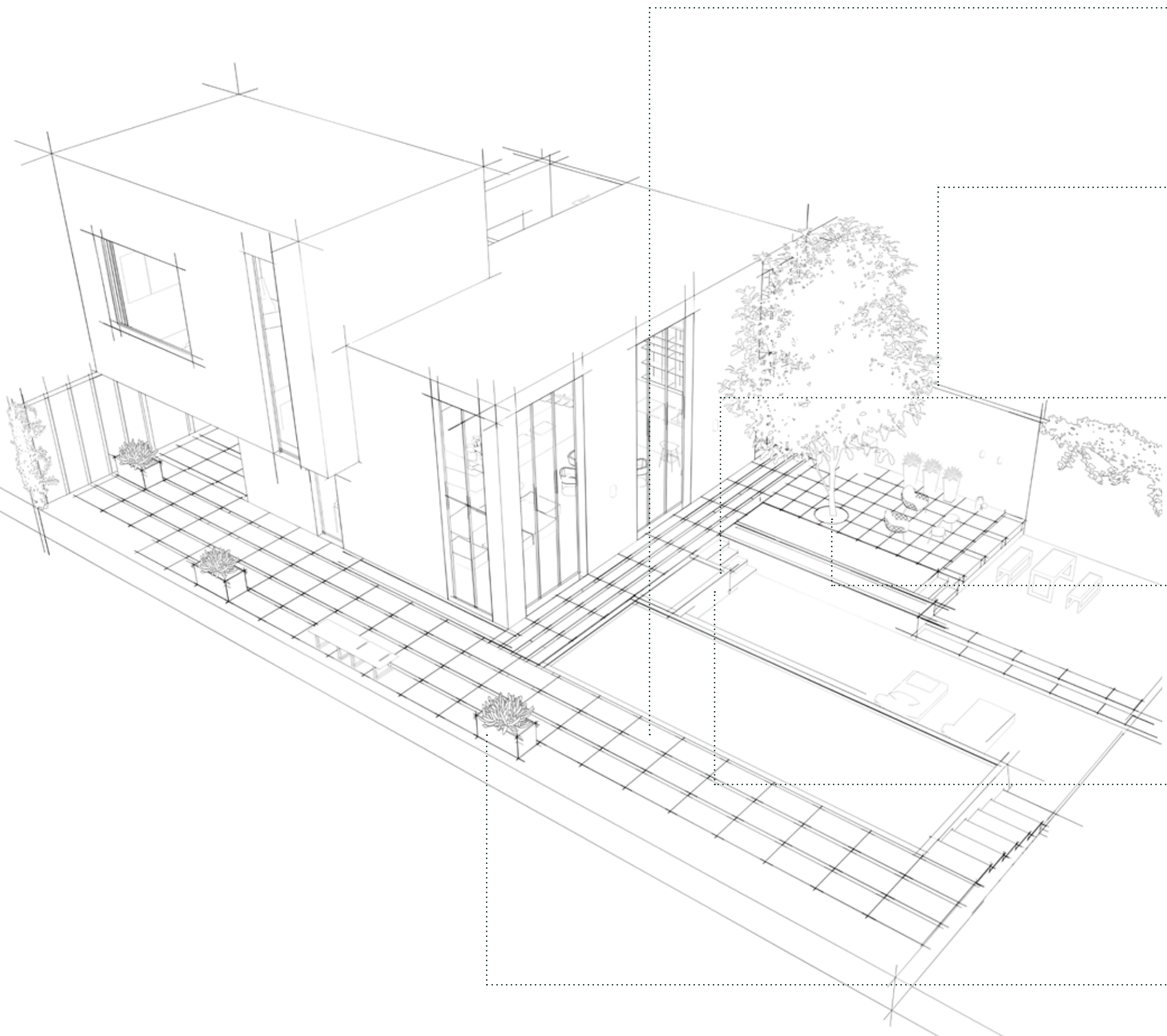

**Path**  
Weg  
Camminamenti  
Chemin  
Sentero

p.13



**Wall cover**  
Mauerabdeckung  
Coprimuro  
Couvre-murs  
Tapamuro

p.17

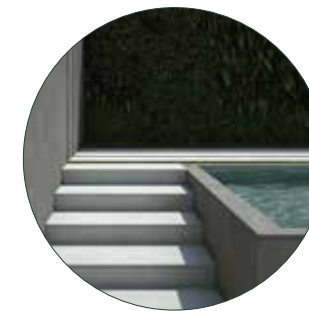
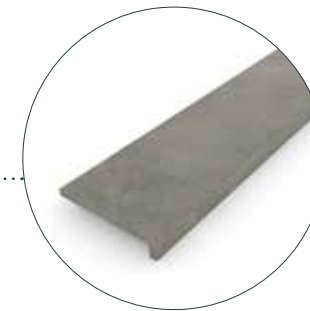

**Step**  
Stufe  
Gradino  
Nez de marche  
Paso

p.21

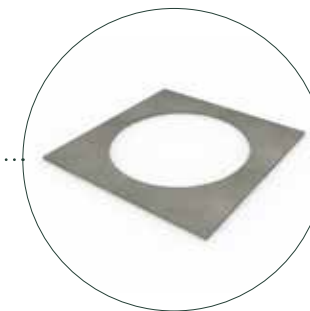

**Flowerbed**  
Beet  
Aiuola  
Parterre  
Arriate

p.27

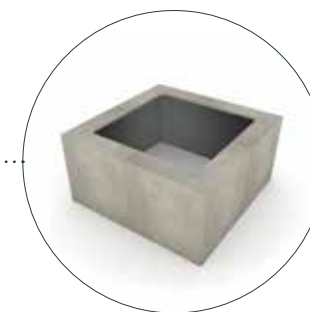

**Flowerbed cover**  
Beetaußenverkleidung  
Rivestimento per aiuola  
Revêtement pour parterre  
Revestimeinto para arriate

p.31



**Flower Box**  
Blumenkasten  
Fioriera  
Bac à Fleurs  
Florero

p.35





**Path**

Gartenweg  
Camminamento  
Chemin  
Sendero

Path | Gartenweg | Camminamento | Chemin | Sendero



**mile stone**  
carbon black

Path | Gartenweg | Camminamento | Chemin | Sendero



**mile stone**  
carbon black

**quartz stone**

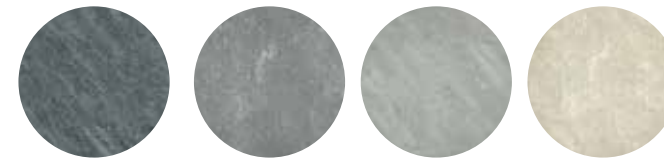

qs\_super black    qs\_black    qs\_grey    qs\_beige

**mile stone**

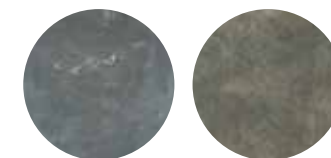

carbon black    rusted brown

**urban**

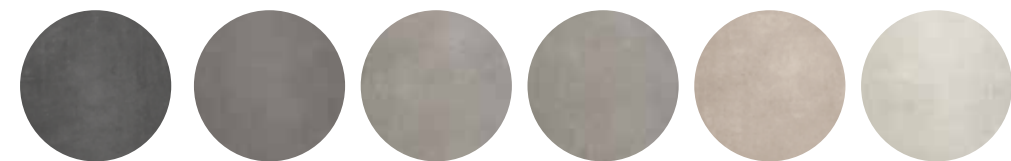

urban anthracite    urban dove    urban grey    urban ivory    urban sand    urban white

**in\_wood**



durmast    canaletto    maple



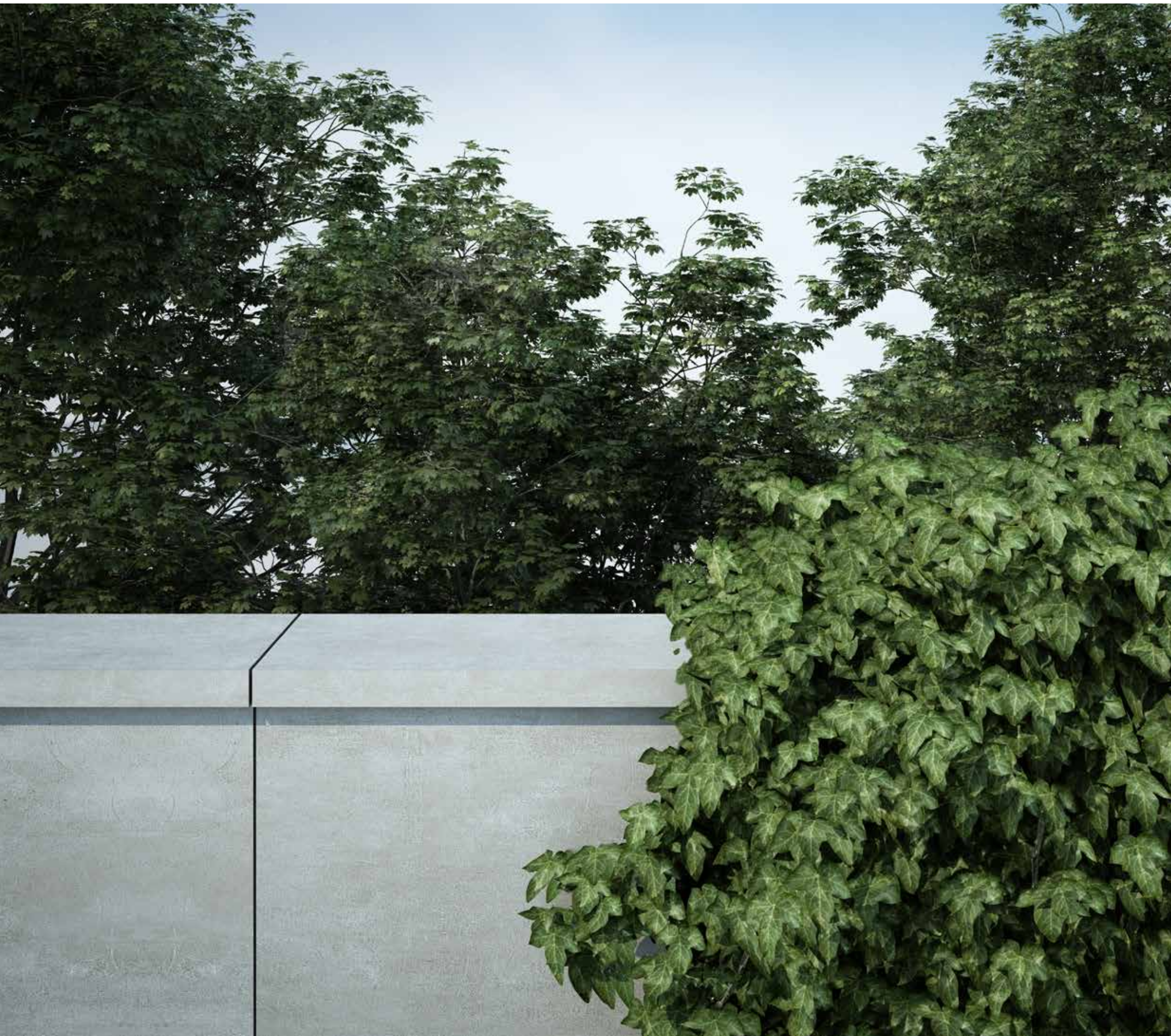

**Wallcover**

Mauerabdeckung

Coprimuro

Couvre-murs

Tapamuro



### WALLCOVER\_I

Wallcover | Mauerbadeckung | Coprimuro | Couvre-murs | Tapamuro



quartz stone  
qs\_grey

### WALLCOVER\_U

Wallcover | Mauerbadeckung | Coprimuro | Couvre-murs | Tapamuro



quartz stone  
qs\_grey

### quartz stone

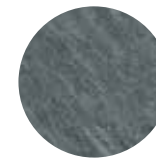

qs\_super black

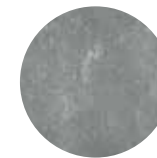

qs\_black

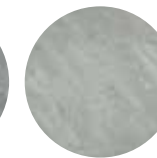

qs\_grey

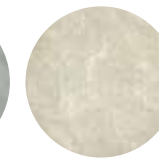

qs\_beige

### mile stone



carbon black

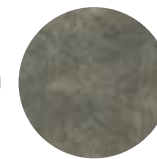

rusted brown

### urban

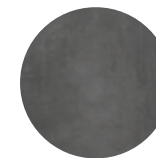

urban anthracite



urban dove

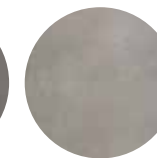

urban grey

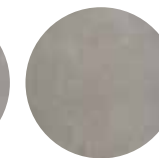

urban ivory

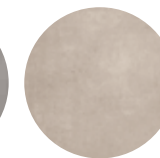

urban sand



urban white

### in\_wood



durmast



canaletto

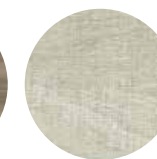

maple



**Step**  
Stufe  
Gradino  
Nez de marche  
Paso



**STEP\_J**

**Step** | Stufe | Gradino | Nez de marche | Paso



**urban**  
urban dove

**STEP\_L**

**Step** | Stufe | Gradino | Nez de marche | Paso



**urban**  
urban grey

**Step with grooves** | Stufe mit Rillen | Gradino con scanalature | Nez de marche strié | Paso con ranuras



**urban**  
urban dove

**Step with grooves** | Stufe mit Rillen | Gradino con scanalature | Nez de marche strié | Paso con ranuras



**urban**  
urban grey

**STEP\_B**

**Step** | Stufe | Gradino | Nez de marche | Paso



**urban**  
urban ivory

**Step with grooves** | Stufe mit Rillen | Gradino con scanalature | Nez de marche strié | Paso con ranuras



**urban**  
urban ivory

**quartz stone**

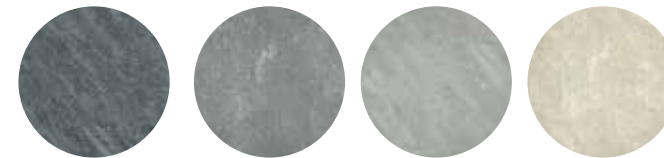

qs\_super black    qs\_black    qs\_grey    qs\_beige

**mile stone**

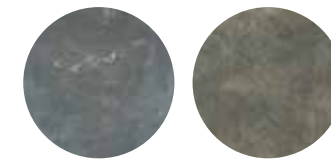

carbon black    rusted brown

**urban**

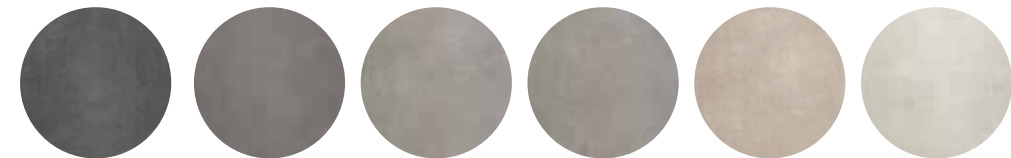

urban anthracite    urban dove    urban grey    urban ivory    urban sand    urban white

**in\_wood**



durmast    canaletto    maple





**Flowerbed**

Beet  
Aiuola  
Parterre  
Arriate



### FLOWERBED\_4

Flowerbed | Beet | Aiuola | Parterre | Arriate



urban  
urban grey

### FLOWERBED\_6

Flowerbed | Beet | Aiuola | Parterre | Arriate



urban  
urban grey

#### quartz stone

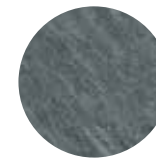

qs\_super black



qs\_black

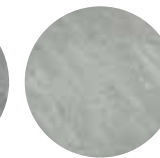

qs\_grey

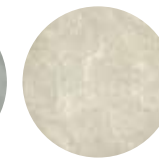

qs\_beige

#### mile stone



carbon black

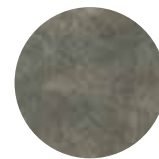

rusted brown

#### urban

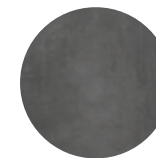

urban anthracite



urban dove

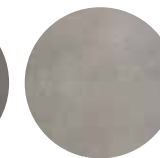

urban grey

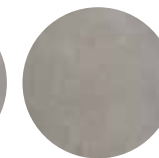

urban ivory

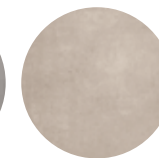

urban sand



urban white

#### in\_wood



durmast



canaletto



maple



**Flowerbed cover**

Beetaußenverkleidung  
Rivestimento per aiuola  
Revêtement pour parterre  
Revestimiento para arriate

### FLBCOVER\_120R

**Flowerbed cover** | Beetaußenverkleidung | Rivestimento per Aiuola  
Revêtement pour parterre | Revestimiento para arriate

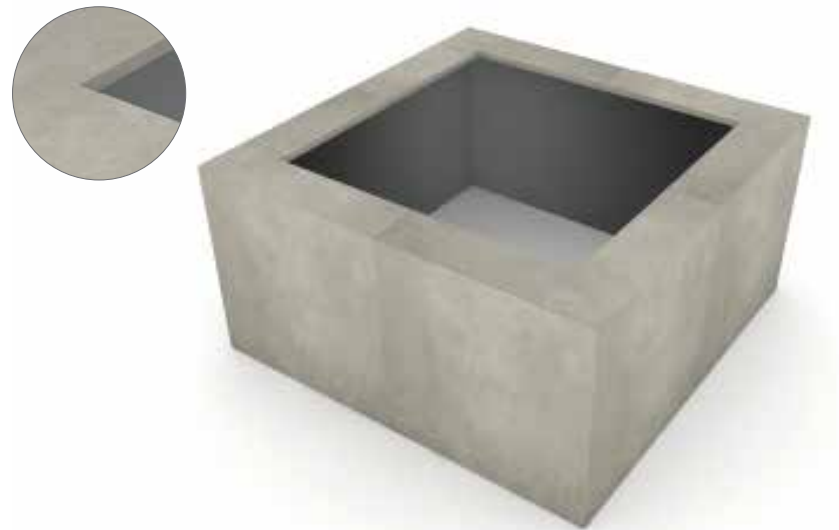

**urban**  
urban ivory

### FLBCOVER\_120

**Flowerbed cover** | Beetaußenverkleidung | Rivestimento per Aiuola  
Revêtement pour parterre | Revestimiento para arriate

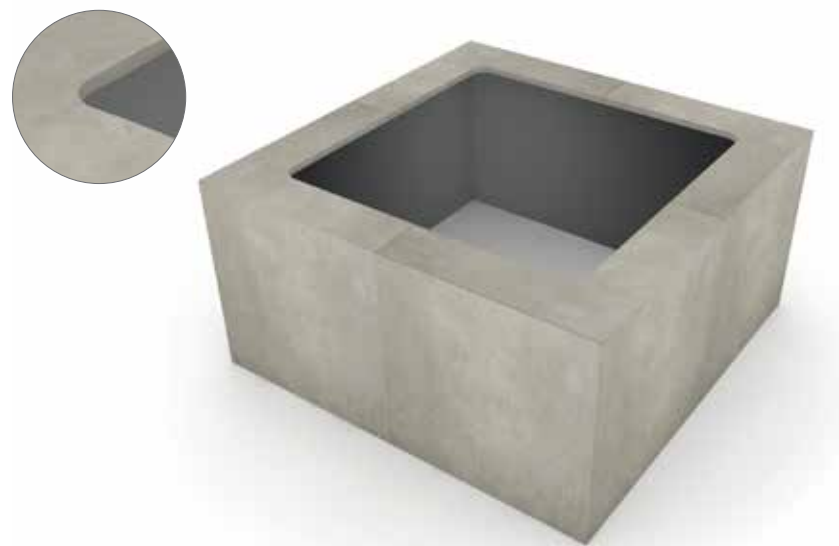

**urban**  
urban ivory

### quartz stone

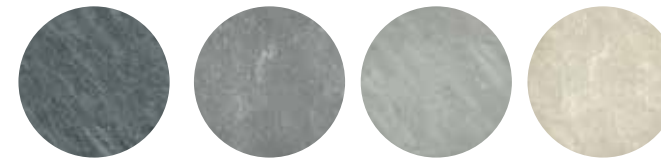

qs\_super black    qs\_black    qs\_grey    qs\_beige

### mile stone

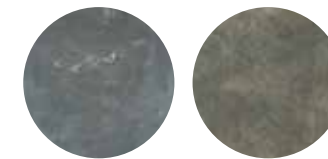

carbon black    rusted brown

### urban

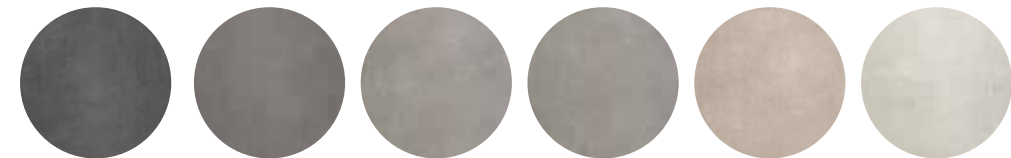

urban anthracite    urban dove    urban grey    urban ivory    urban sand    urban white

### in\_wood



durmast    canaletto    maple





**Flower Box**  
Blumenkasten  
Fioriera  
Bac à Fleurs  
Florero



**BOX\_60**

**Flower box** | Blumenkasten | Fioriera | Bac à Fleurs | Florero



**urban**  
urban ivory

**BOX\_120**

**Flower box** | Blumenkasten | Fioriera | Bac à Fleurs | Florero



**urban**  
urban ivory

**quartz stone**

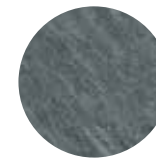

qs\_super black



qs\_black

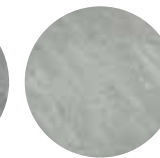

qs\_grey

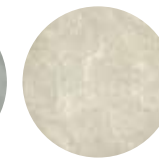

qs\_beige

**mile stone**



carbon black

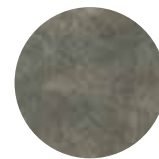

rusted brown

**urban**

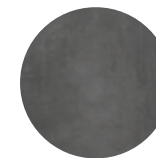

urban anthracite



urban dove

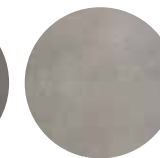

urban grey

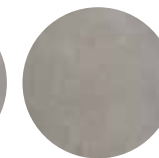

urban ivory

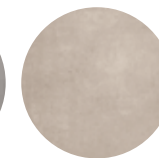

urban sand



urban white

**in\_wood**



durmast



canaletto

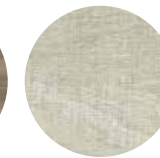

maple



# FURNITURE



# Furniture

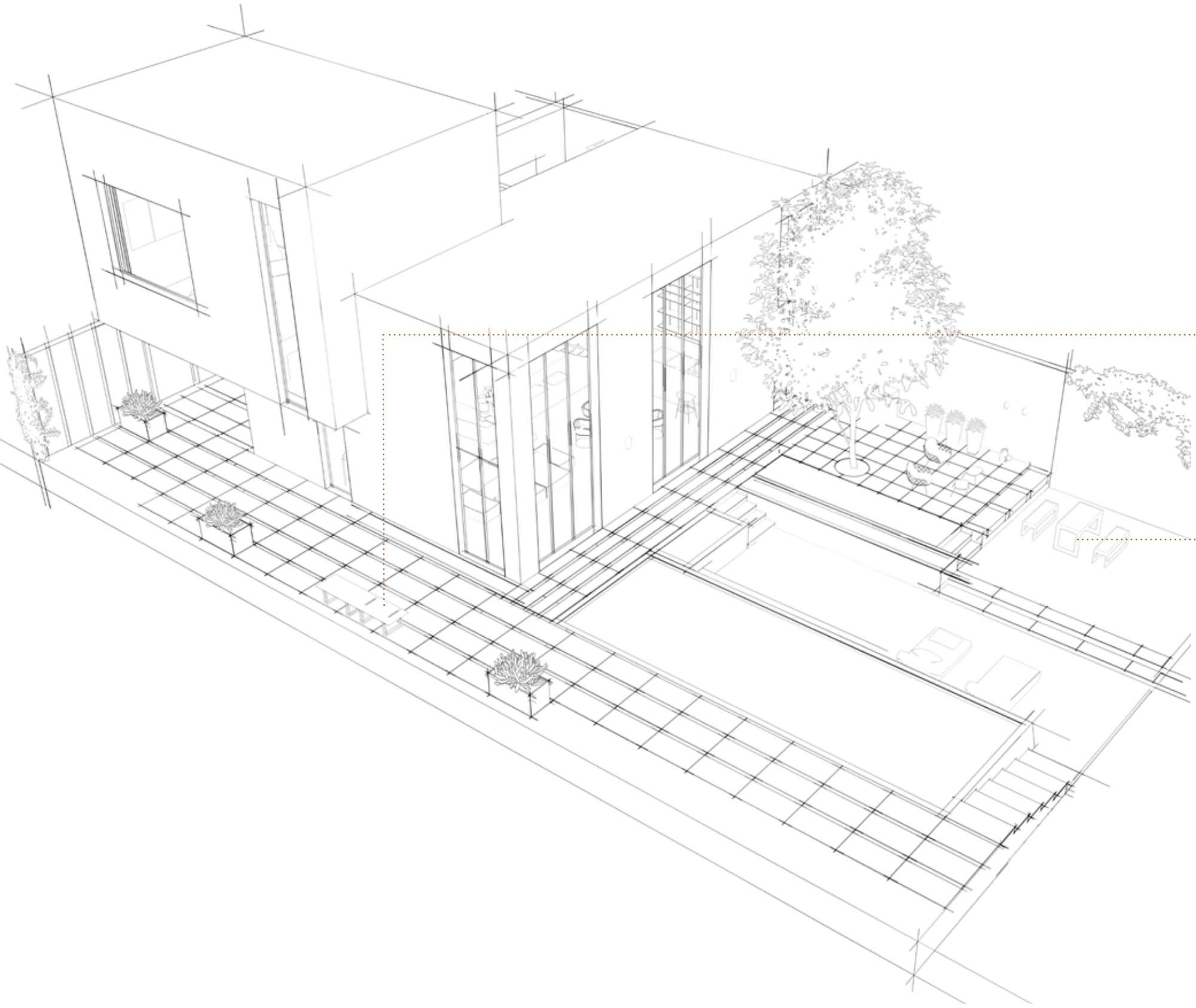

**Bench**  
Sitzbank  
Panchina  
Banquette  
Banco

p.43



**Table**  
Tisch  
Tavolo  
Table  
Mesa

p.49

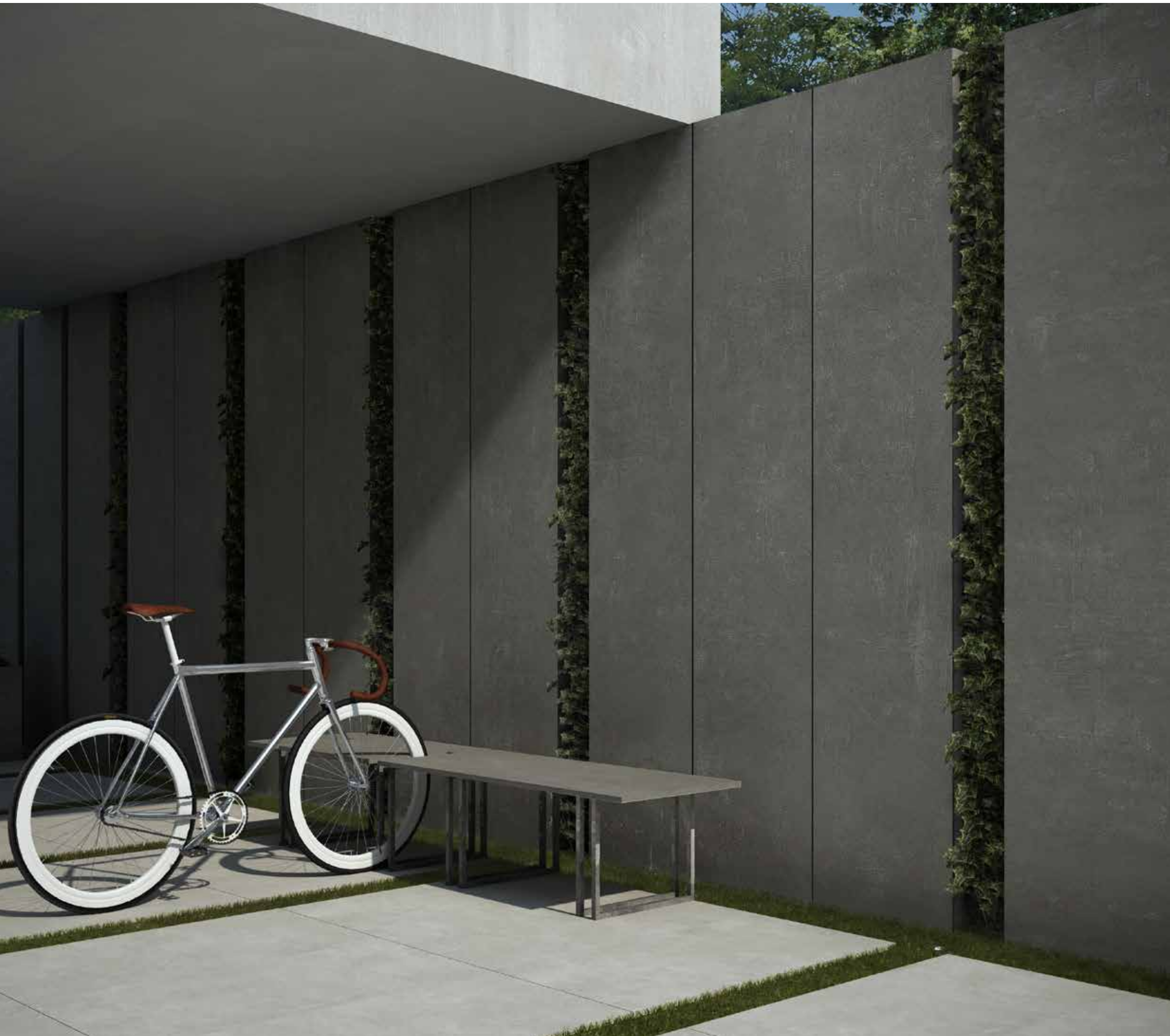

**Bench**  
Sitzbank  
Panchina  
Banc  
Banco

## BENCH\_FRAME

Bench | Sitzbank | Panchina | Banc | Banco



**in\_wood**  
canaletto

### quartz stone

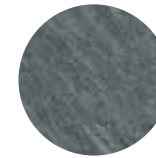

qs\_super black

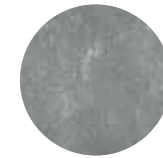

qs\_black

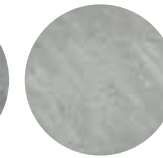

qs\_grey

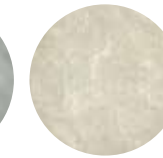

qs\_beige

### mile stone



carbon black

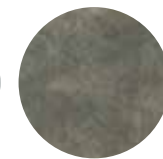

rusted brown

### urban

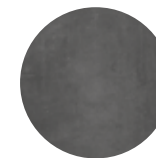

urban anthracite



urban dove

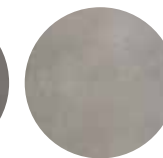

urban grey

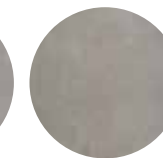

urban ivory

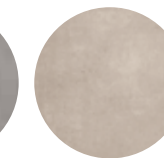

urban sand

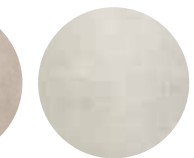

urban white

### in\_wood



durmast



canaletto

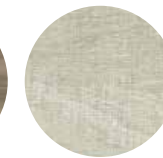

maple



**BENCH\_60**

**Bench** | Sitzbank | Panchina | Banc | Banco



**urban**  
urban grey

**BENCH\_30**

**Bench** | Sitzbank | Panchina | Banc | Banco



**urban**  
urban grey

**BENCH\_60B**

**Bench with bike rack** | Sitzbank mit Fahrradständer | Panchina con portabici | Banc avec porte-vélo  
Banco con portabicicletas



**urban**  
urban grey

**quartz stone**

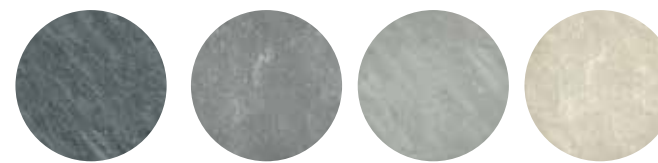

qs\_super black    qs\_black    qs\_grey    qs\_beige

**mile stone**

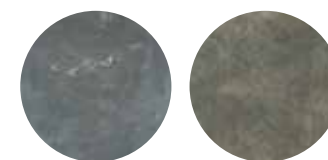

carbon black    rusted brown

**urban**



urban anthracite    urban dove    urban grey    urban ivory    urban sand    urban white

**in\_wood**



durmast    canaletto    maple





**Table**  
Tisch  
Tavolo  
Table  
Mesa



**TABLE\_FRAME75**

Table | Tisch | Tavolo | Table | Mesa



**in\_wood**  
canaletto

**TABLE\_FRAME45**

Table | Tisch | Tavolo | Table | Mesa



**in\_wood**  
canaletto

**quartz stone**

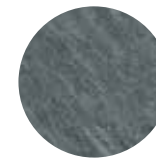

qs\_super black



qs\_black

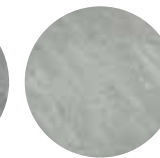

qs\_grey

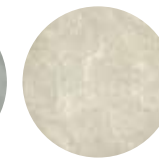

qs\_beige

**mile stone**



carbon black

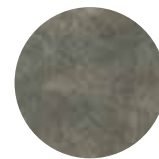

rusted brown

**urban**

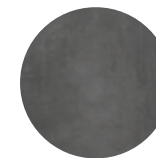

urban anthracite



urban dove

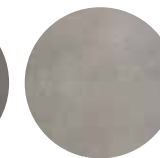

urban grey

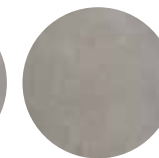

urban ivory

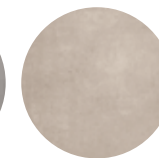

urban sand



urban white

**in\_wood**



durmast



canaletto

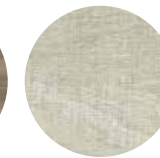

maple



### TABLE\_75

Table | Tisch | Tavolo | Table | Mesa \*



**urban**  
urban grey

### urban



\*

The table top has been developed with an internal structure, clad in 6mm grès porcelain.

Die Tischplatte wird mit einer Innenstruktur gefertigt und ist auf allen Sichtflächen mit Feinsteinzeug in 6mm Dicke beschichtet.

Il piano del tavolo è realizzato con struttura interna rivestita in gres porcellanato 6mm.

Le dessus de la table est réalisé avec une structure interne revêtue de grès porcelainé 6 mm

La mesa està realizada con estructura interna revestida en gres porcelánico de 6 mm

Table and Benches | Tisch und Bänke | Tavolo e panchine | Table et Banc | Mesa y Bancos





Table and Benches | Tisch und Bänke | Tavolo e panchine | Table et Banc | Mesa y Bancos





WATER



# Water

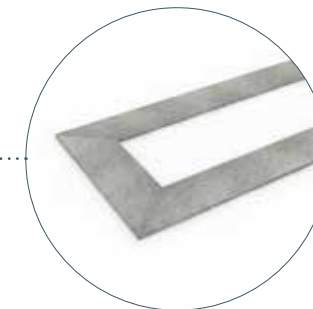
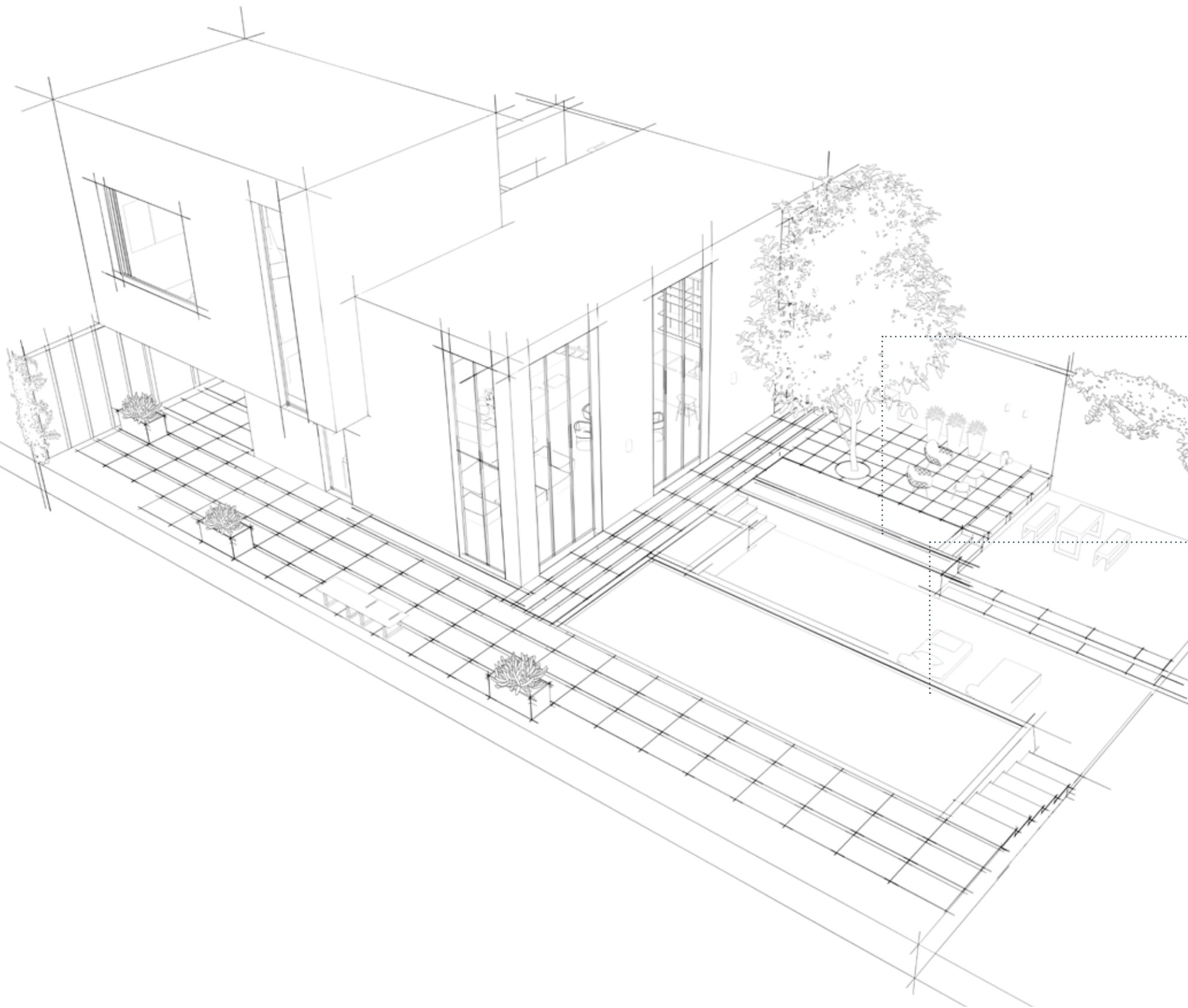

**Tub**  
Wanne  
Vasca  
Bassin  
Bañera

p. 63

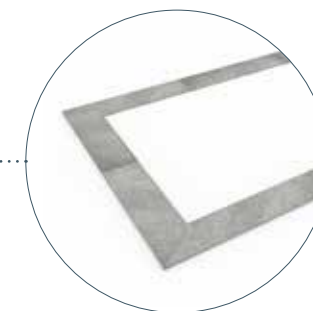

**Swimming pool**  
Schwimmbad  
Piscina  
Piscine  
Piscina

p.67

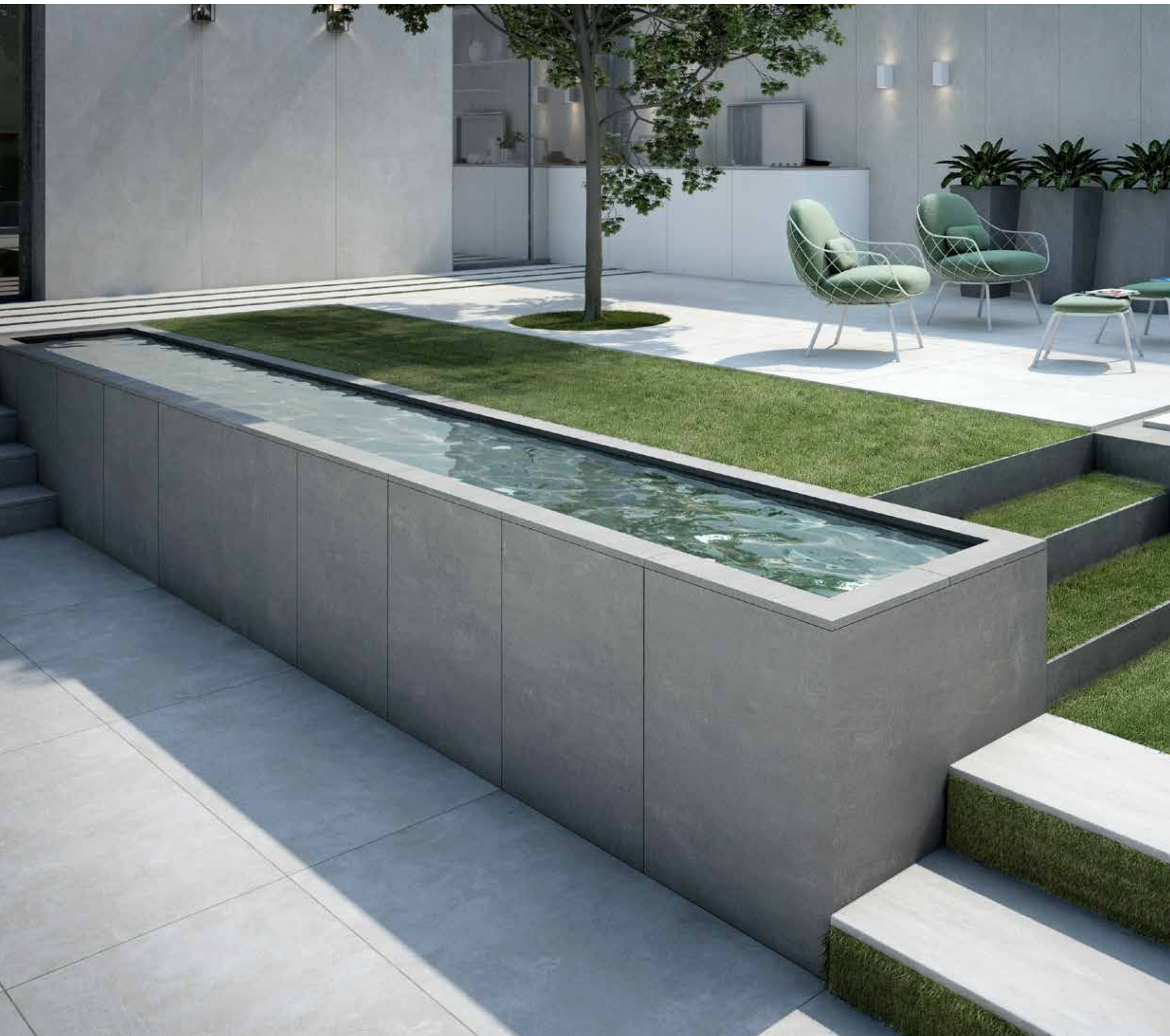

**Tub**  
Wanne  
Vasca  
Bassin  
Bañera



## TUB

Tub edge | Wannenrand | Bordo Vasca | Bord de le bassin | Borde de la bañera



quartz stone  
qs\_grey

### quartz stone

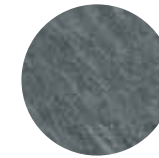

qs\_super black

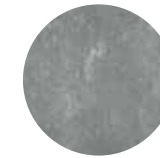

qs\_black

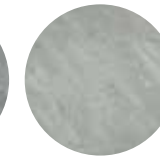

qs\_grey

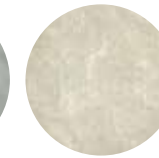

qs\_beige

### mile stone



carbon black

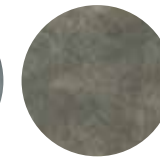

rusted brown

### urban



urban anthracite

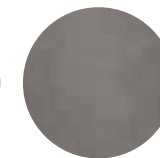

urban dove

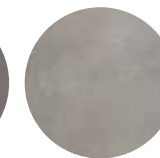

urban grey

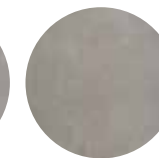

urban ivory

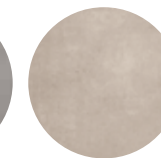

urban sand



urban white

### in\_wood



durmast



canaletto

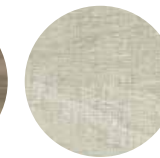

maple





**Swimming pool**

Schwimmbad

Piscina

Piscine

Piscina



## POOL

Poolside | Beckenrand | Bordo Piscina | Bord de la Piscine | Borde de la piscina

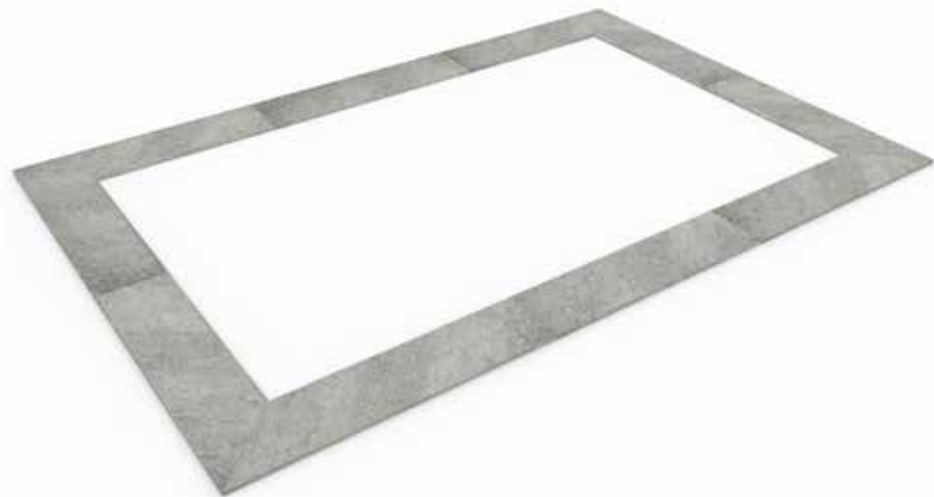

quartz stone  
qs\_grey

### quartz stone

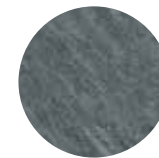

qs\_super black

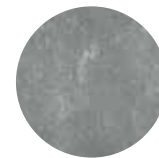

qs\_black

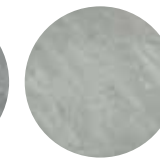

qs\_grey

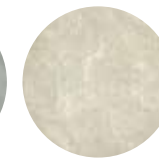

qs\_beige

### mile stone



carbon black



rusted brown

### urban

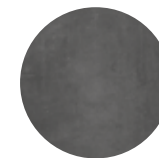

urban anthracite



urban dove

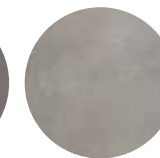

urban grey

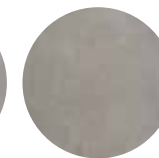

urban ivory

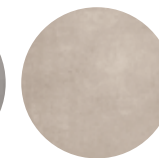

urban sand



urban white

### in\_wood



durmast



canaletto



maple

**Data sheets**

Technische Datenblätter

Schede tecniche

Fiches techniques

Fichas técnicas



# Green

## Path | Gartenweg | Camminamento | Chemin | Sendero

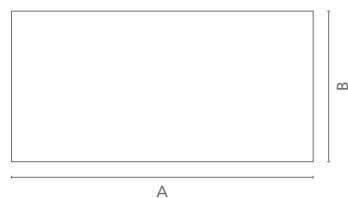
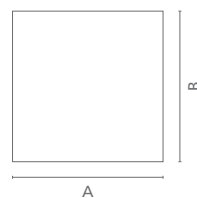
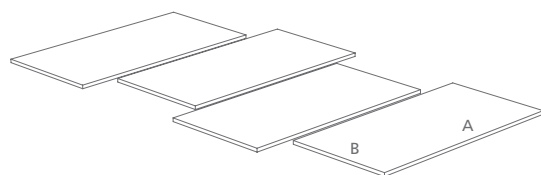
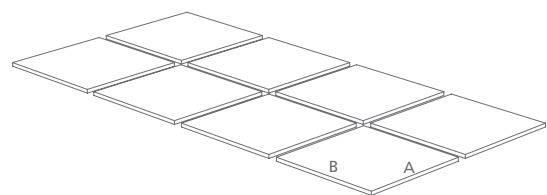

| A     | B     |
|-------|-------|
| 60 cm | 60 cm |

| A      | B     |
|--------|-------|
| 120 cm | 60 cm |

## Wallcover | Mauerabdeckung | Coprimuro | Covre-murs | Tapamuro

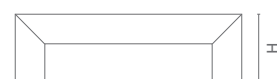
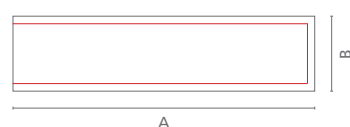
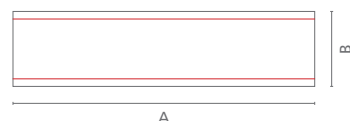
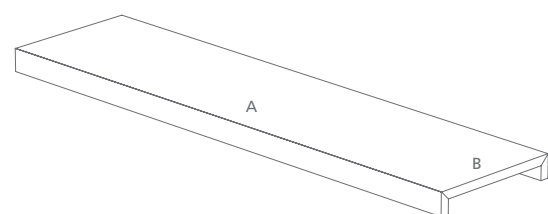
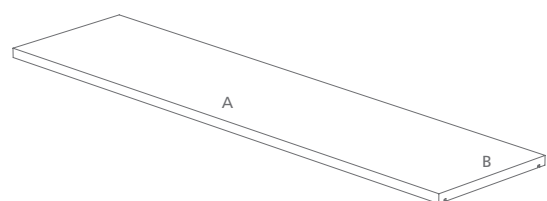

| Ref.        | ** | A      | B         |
|-------------|----|--------|-----------|
| WALLCOVER_I |    | 120 cm | 20- 60 cm |

| Ref.        | * / ** | A      | B          | H    |
|-------------|--------|--------|------------|------|
| WALLCOVER_U |        | 120 cm | 20 - 50 cm | 5 cm |

## Step | Stufe | Gradino | Nez de marche | Paso

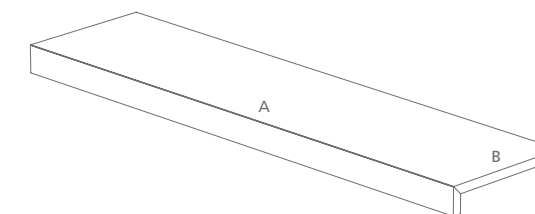
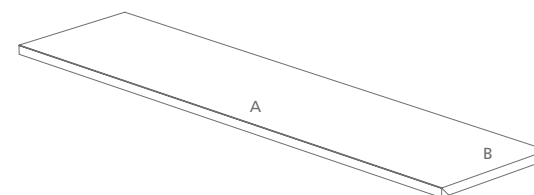

with grooves | mit Rillen | con scanalature | strié | con ranuras

with grooves | mit Rillen | con scanalature | strié | con ranuras

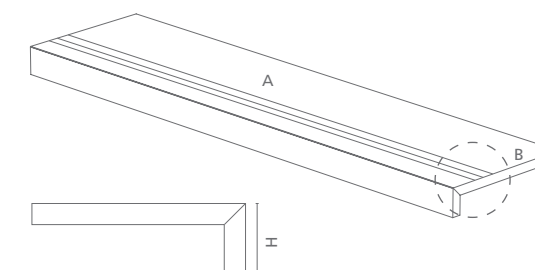
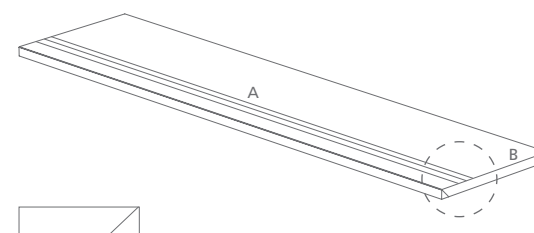

| Ref.   | * / ** | A      | B          |
|--------|--------|--------|------------|
| STEP_J |        | 120 cm | 28 - 40 cm |

| Ref.   | * / ** | A      | B          | H         |
|--------|--------|--------|------------|-----------|
| STEP_L |        | 120 cm | 28 - 40 cm | 4 - 20 cm |

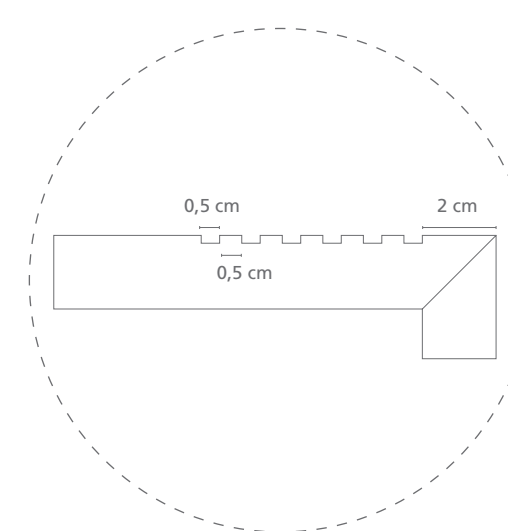
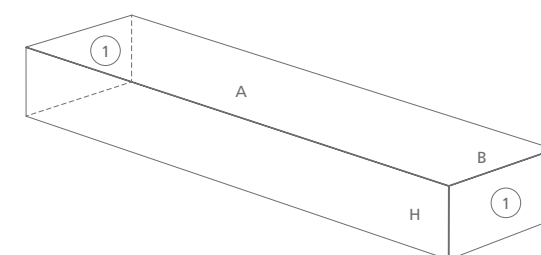

with grooves | mit Rillen | con scanalature | strié | con ranuras

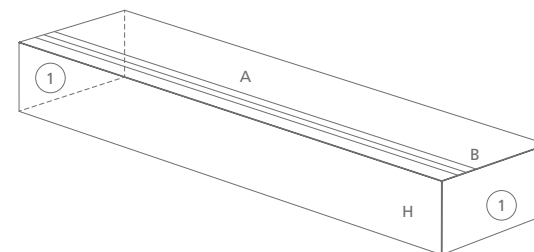

| Ref.   | * / ** | A      | B          | H         |
|--------|--------|--------|------------|-----------|
| STEP_B |        | 120 cm | 28 - 40 cm | 4 - 20 cm |
| ①      |        |        | 28 - 40 cm | 4 - 20 cm |

**Flowerbed** | Beet | Aiuola | Parterre | Arriate

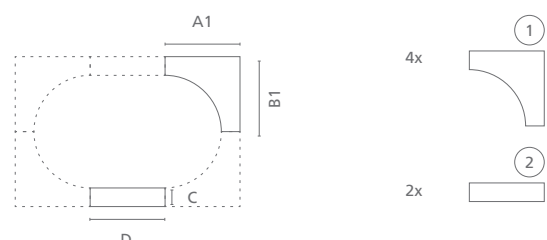
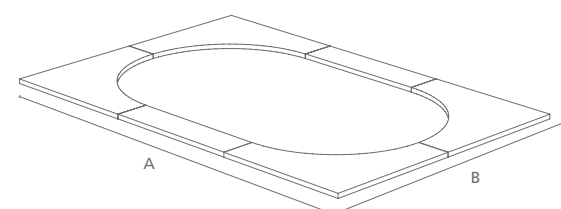
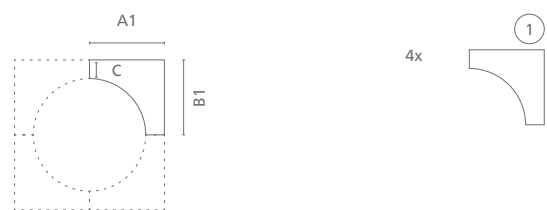
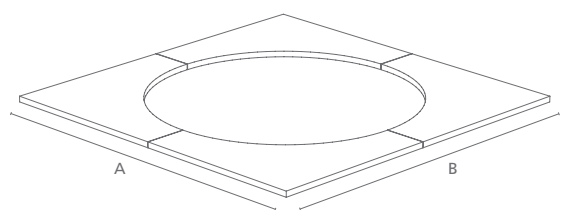

| Ref.        | A      | B      | C     |
|-------------|--------|--------|-------|
| FLOWERBED_4 | 120 cm | 120 cm | 15 cm |
| FLOWERBED_6 | 180 cm | 120 cm | 15 cm |

|   | A     | B     | C     | D     |
|---|-------|-------|-------|-------|
| ① | 60 cm | 60 cm | 15 cm |       |
| ② |       |       | 15 cm | 60 cm |

**Flower box** | Blumenkasten | Fioriera | Bac à Fleurs | Florero

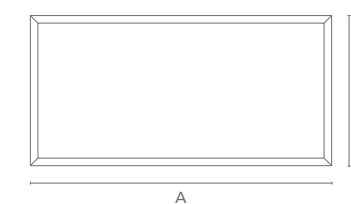
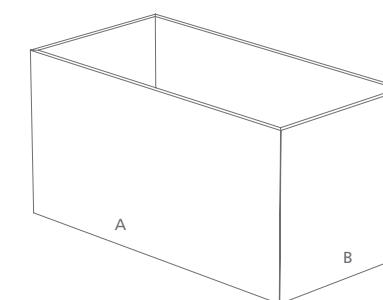
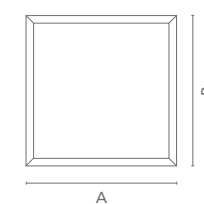
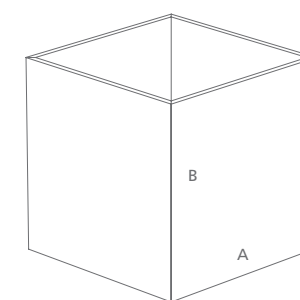

| Ref.   | * / ** | A     | B     |
|--------|--------|-------|-------|
| BOX_60 |        | 60 cm | 60 cm |

| Ref.    | * / ** | A      | B     |
|---------|--------|--------|-------|
| BOX_120 |        | 120 cm | 60 cm |

**Flowerbed cover** | Beetaußenverkleidung | Rivestimento per Aiuola | Revêtement por parterre  
Revestemento para arriate

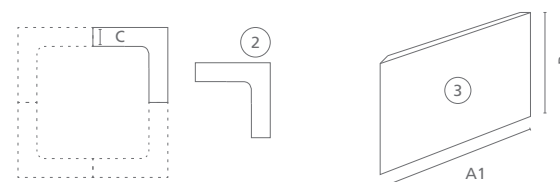
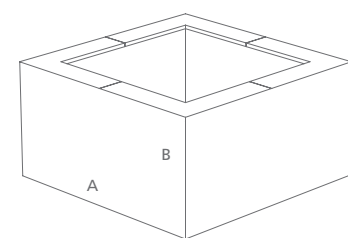
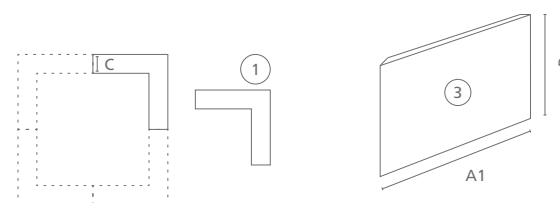
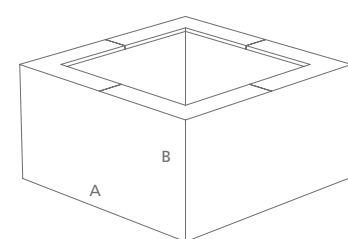

| Ref.          | ** | A      | B     | C     |
|---------------|----|--------|-------|-------|
| FLBCOVER_120R |    | 120 cm | 60 cm | 15 cm |
| FLBCOVER_120  |    | 120 cm | 60 cm | 15 cm |

|   | A      | B     | C     |
|---|--------|-------|-------|
| ① | 60 cm  | 60 cm | 15 cm |
| ② | 60 cm  | 60 cm | 15 cm |
| ③ | 120 cm | 60 cm |       |

\* The product is delivered fully assembled.  
Das Produkt wird komplett montiert geliefert.  
Il prodotto viene consegnato già assemblato.  
Le produit est livré déjà assemblé.  
El producto se entrega ya montado.

\*\* The product can be customized.  
Das Produkt kann angepasst werden.  
Il prodotto può essere realizzato su misura.  
Le produit peut être personnalisé.  
El producto se puede personalizar.



# Furniture

## Bench | Sitzbank | Panchina | Panquettes | Banco

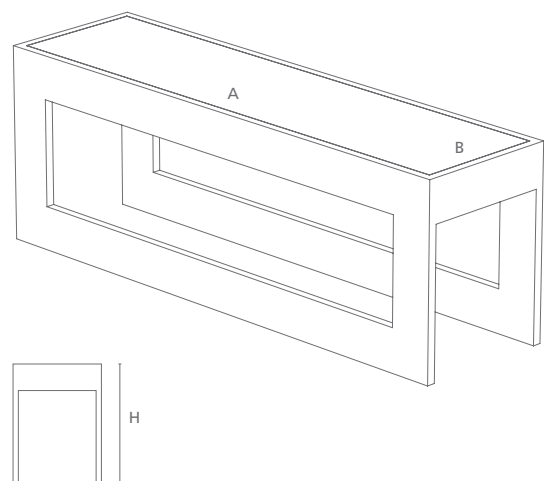

| Ref.        | * / ** | A      | B     | H     |
|-------------|--------|--------|-------|-------|
| BENCH_FRAME |        | 124 cm | 34 cm | 45 cm |
| BENCH_FRAME |        | 244 cm | 34 cm | 45 cm |

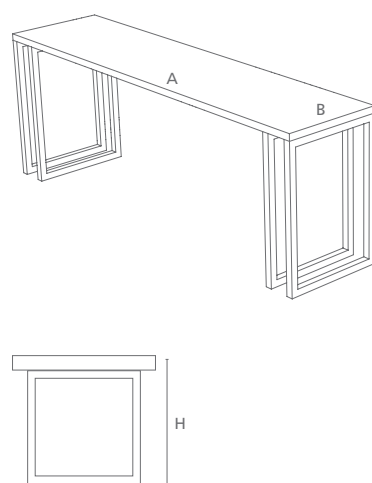

| Ref.     | * / ** | A      | B     | H     |
|----------|--------|--------|-------|-------|
| BENCH_30 |        | 120 cm | 30 cm | 45 cm |

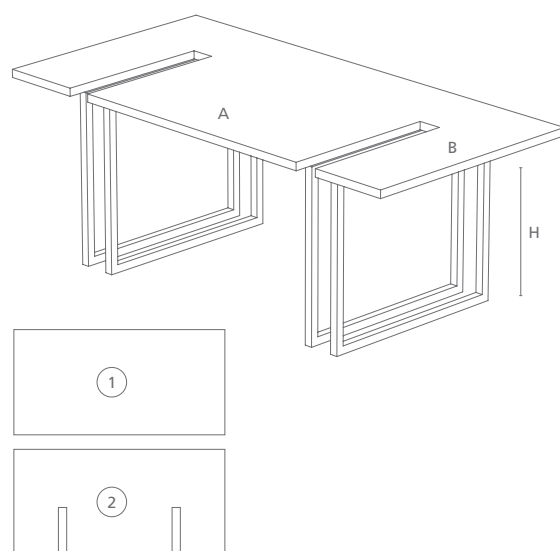

| Ref.        | * | A      | B     | H     | C    |
|-------------|---|--------|-------|-------|------|
| BENCH_60 ①  |   | 120 cm | 60cm  | 45 cm | 6 cm |
| BENCH_60B ② |   | 120 cm | 60 cm | 45 cm | -    |

## Table | Tisch | Tavolo | Table | Mesa

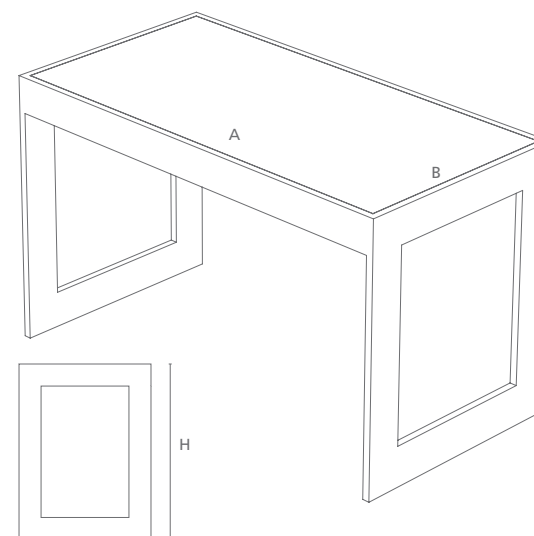

| Ref.          | * / ** | A      | B     | H     |
|---------------|--------|--------|-------|-------|
| TABLE_FRAME75 |        | 124 cm | 64 cm | 45 cm |
| TABLE_FRAME75 |        | 244 cm | 64 cm | 45 cm |

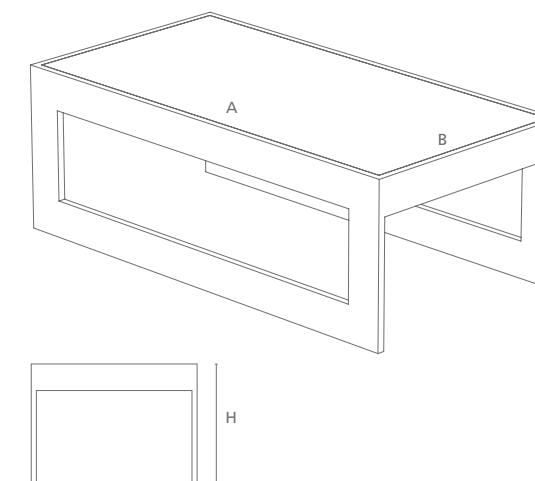

| Ref.          | * / ** | A      | B     | H     |
|---------------|--------|--------|-------|-------|
| TABLE_FRAME45 |        | 124 cm | 64 cm | 75 cm |
| TABLE_FRAME45 |        | 244cm  | 64 cm | 75 cm |

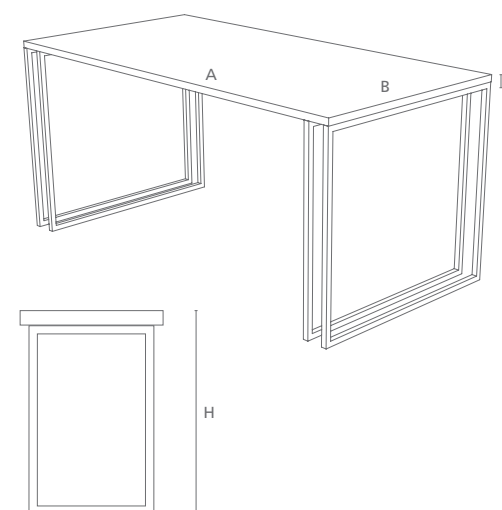

| Ref.     | * / ** | A      | B      | C      | H     |
|----------|--------|--------|--------|--------|-------|
| TABLE_75 |        | 160 cm | 80 cm  | 2,5 cm | 75 cm |
| TABLE_75 |        | 240 cm | 80 cm  | 2,5 cm | 75 cm |
| TABLE_75 |        | 300 cm | 100 cm | 2,5 cm | 75 cm |

\* The product is delivered fully assembled.  
 Das Produkt wird komplett montiert geliefert.  
 Il prodotto viene consegnato già assemblato.  
 Le produit est livré déjà assemblé.  
 El producto se entrega ya montado.

\*\* The product can be customized.  
 Das Produkt kann angepasst werden.  
 Il prodotto può essere realizzato su misura.  
 Le produit peut être personnalisé.  
 El producto se puede personalizar.

# Water

## Tub edge | Wannenrand | Bordo vasca | Bord de le bassin | Borde de la bañera

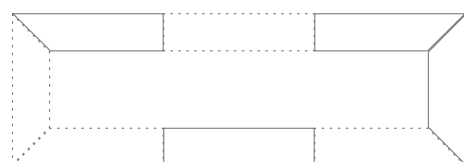
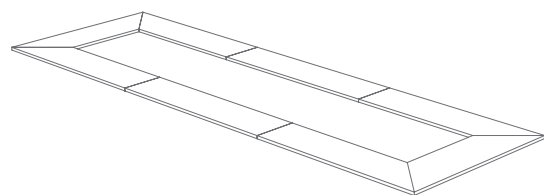

| Ref.  | ** | A      | B     | C   |
|-------|----|--------|-------|-----|
| TUB_T |    | 120 cm | 30 cm | 45° |

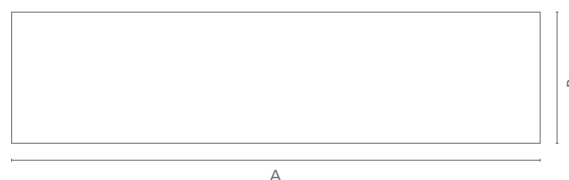

| Ref.    | ** | A      | B     | C   |
|---------|----|--------|-------|-----|
| TUB_45L |    | 120 cm | 30 cm | 45° |
| TUB_45R |    | 120 cm | 30 cm | 45° |

| Ref.   | ** | A      | B     |
|--------|----|--------|-------|
| TUB_ST |    | 120 cm | 30 cm |

## Poolside | Beckenrand | Bordo piscina | Bord de la piscine | Borde de la piscina

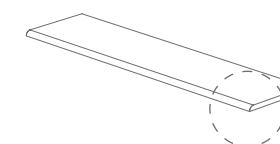
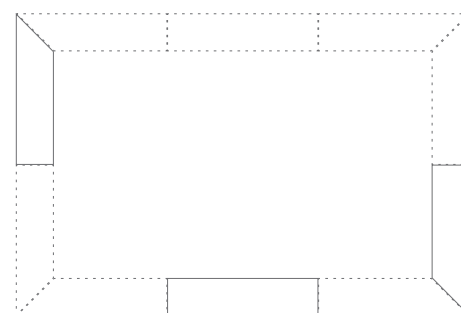
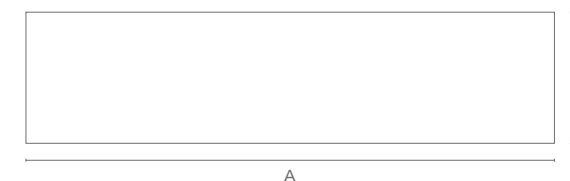
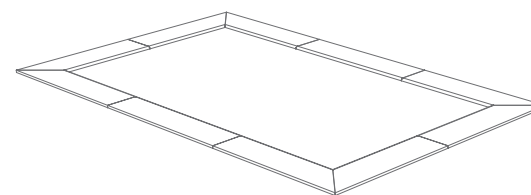

| Ref.    | ** | A      | B     |
|---------|----|--------|-------|
| POOL_ST |    | 120 cm | 30 cm |

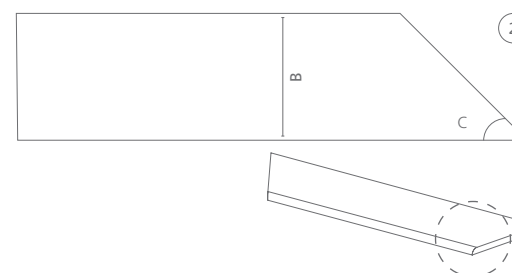
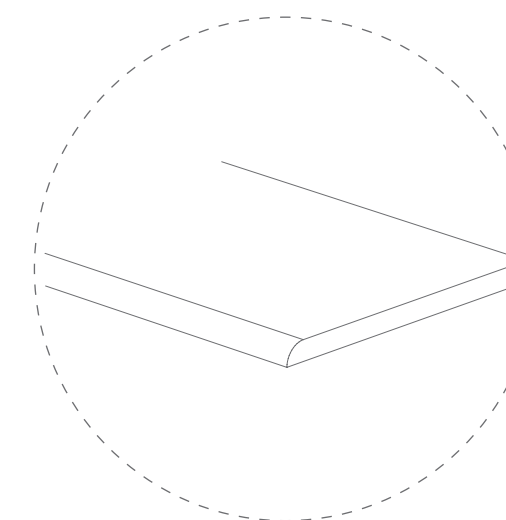
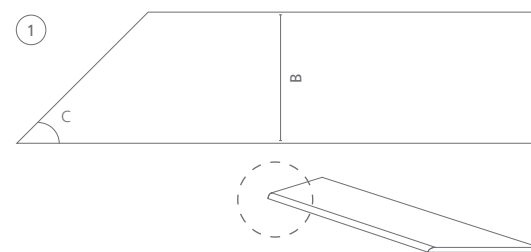

| Ref.     | ** | A      | B     | C   |
|----------|----|--------|-------|-----|
| POOL_45L |    | 120 cm | 30 cm | 45° |
| POOL_45R |    | 120 cm | 30 cm | 45° |

\* The product is delivered fully assembled.  
 Das Produkt wird komplett montiert geliefert.  
 Il prodotto viene consegnato già assemblato.  
 Le produit est livré déjà assemblé.  
 El producto se entrega ya montado.

\*\* The product can be customized.  
 Das Produkt kann angepasst werden.  
 Il prodotto può essere realizzato su misura.  
 Le produit peut être personnalisé.  
 El producto se puede personalizar.



**Summary of materials**

Materialübersicht

Riepilogo materiali

Résumé matériaux

Resumen de los materiales

## quartz stone

### qs\_super black

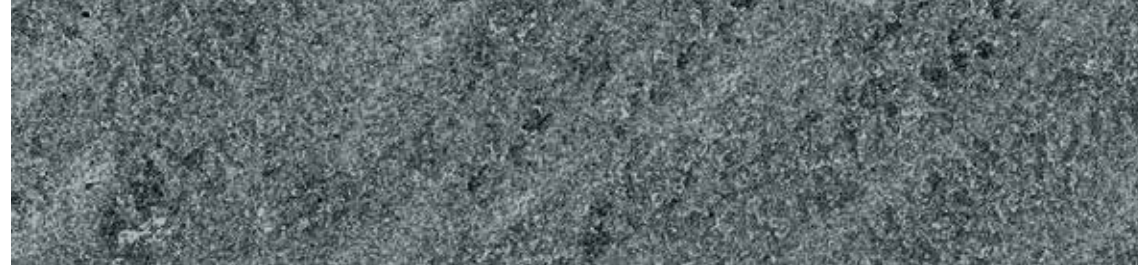

slate | strukturiert | strutturato | structuré | rugoso

R11 A+B UGL

### qs\_black

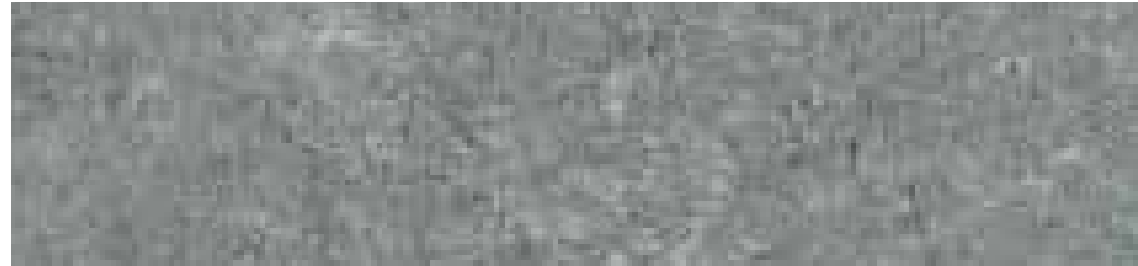

slate | strukturiert | strutturato | structuré | rugoso

R11 A+B UGL

### qs\_grey

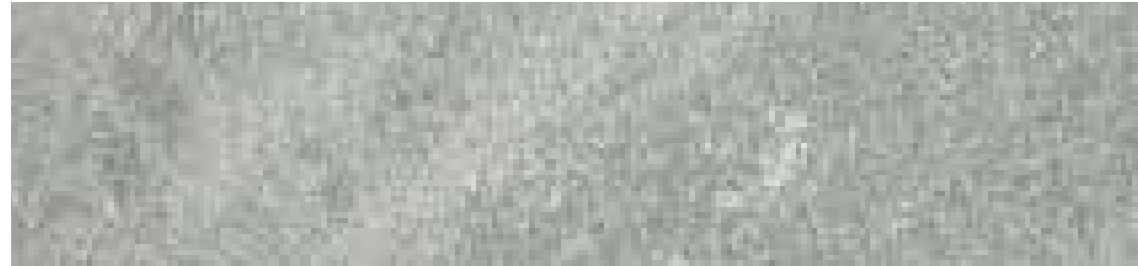

slate | strukturiert | strutturato | structuré | rugoso

R11 A+B UGL

### qs\_beige



slate | strukturiert | strutturato | structuré | rugoso

R11 A+B UGL

## mile stone

### carbon black



natural | natur | naturale | naturel | natural

R11 A+B UGL

### rusted brown



natural | natur | naturale | naturel | natural

R11 A+B UGL



## urban

### urban anthracite

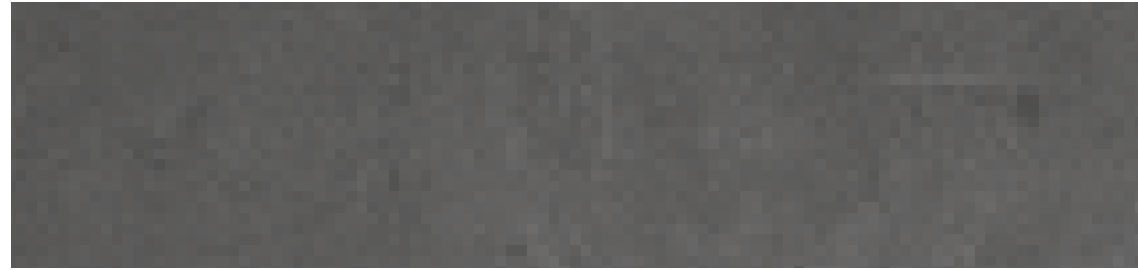

natural | natur | naturale | naturel | natural

20 mm - R11 A+B UGL  
6 mm- R10 A UGL

### urban dove

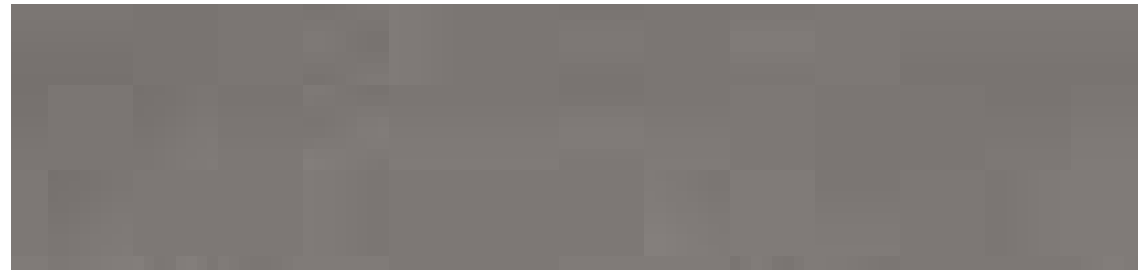

natural | natur | naturale | naturel | natural

20 mm - R11 A+B UGL  
6 mm- R10 A UGL

### urban grey



natural | natur | naturale | naturel | natural

20 mm - R11 A+B UGL  
6 mm- R10 A UGL

### urban ivory



natural | natur | naturale | naturel | natural

20 mm - R11 A+B UGL  
6 mm- R10 A UGL

### urban sand



natural | natur | naturale | naturel | natural

20 mm - R11 A+B UGL  
6 mm- R10 A UGL

### urban white



natural | natur | naturale | naturel | natural

20 mm - R11 A+B UGL  
6 mm- R10 A UGL

## in\_wood

### durmast



natural | natur | naturale | naturel | natural

R11 A+B UGL

### canaletto

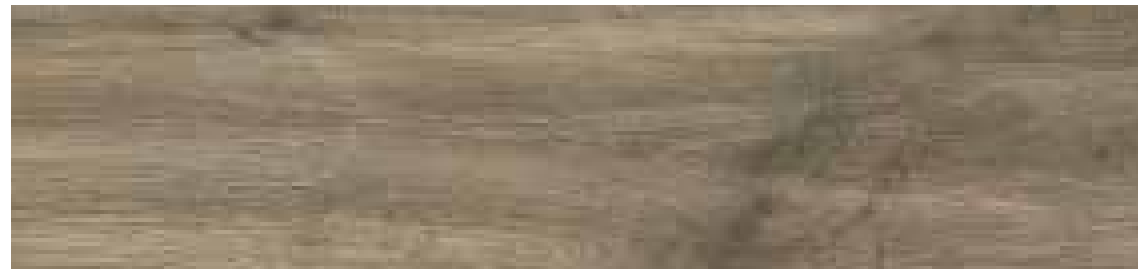

natural | natur | naturale | naturel | natural

R11 A+B UGL

### maple

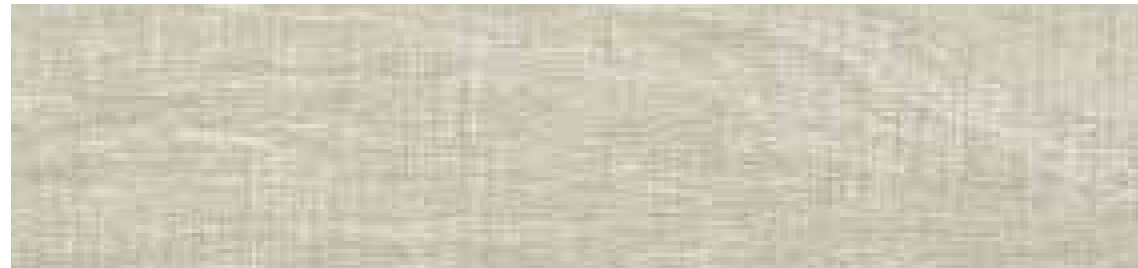

natural | natur | naturale | naturel | natural

R11 A+B UGL



## technical features

squared porcelain stoneware

## technische Eigenschaften

kalibriertes Feinsteinzeug

## caratteristiche tecniche

gres porcellanato rettificato

## caractéristiques techniques

gres cérame rectifié

## características técnicas

gres porcelánico rectificado



products marked with this symbol have been assessed and found to comply with the LEED and BREEAM regulations relating to the minimum recycled content percentage of 40% by weight (of which at least 15% is post-consumer). Certificate is available on request. | die mit diesem Symbol gekennzeichneten Produkte wurden beurteilt und es wurde erklärt, dass sie bezüglich des Mindestprozentsatzes an Recyclingmaterial von 40% des Gewichts (davon mindestens 15% Post-Consumer) den LEED und BREEAM Anforderungen entsprechen. Zertifikat auf Anfrage erhältlich. | i prodotti contrassegnati da questo simbolo sono stati valutati e giudicati conformi ai requisiti LEED e BREEAM in relazione alla percentuale minima di materiale riciclato pari al 40% in peso (di cui almeno 15% post-consumer). Certificato disponibile su richiesta. | les produits accompagnés de ce symbole ont été testés et jugés conformes aux exigences LEED et BREEAM concernant le pourcentage minimal de matériau recyclé (40% du poids dont au moins 15% post-consommation). Certification disponible sur demande. | Los productos marcados con este símbolo han sido validados y adjudicados conforme a los requisitos LEED y BREEAM en relación a los porcentajes mínimos de materiales reciclados iguales al 40% del peso (de ellos, al menos, un 15% post-consumo). Certificado disponible bajo petición.

variability index of the slabs | Variabilitätsindex der Platten | indice di stonizzazione delle lastre | indice de variabilité des dalles | indice de variabilidad de las losas

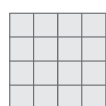

**V1 uniform tone**  
im Farbton homogen  
omogeneo nel tono  
ton homogène  
tonalidad homogénea

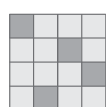

**V2 slightly different tone**  
leicht unregelmäßig im Farbton  
leggermente mosso nel tono  
ton légèrement nuancé  
tono ligeramente variable

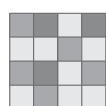

**V3 different tone**  
unregelmäßig im Farbton  
mosso nel tono  
ton nuancé  
tonalidad variable

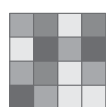













**V4 very variable tone**  
mit starken Unterschieden  
tono molto seminato  
ton très nuancé  
tonalidad muy variable

all Porcelaingres certificates are available upon request and can also be found on our website [www.porcelaingres.com](http://www.porcelaingres.com) | alle Zertifikate von Porcelaingres sind auf Anfrage und auf unserer Website [www.porcelaingres.com](http://www.porcelaingres.com) erhältlich | tutti i certificati di Porcelaingres sono disponibili su richiesta e sul nostro sito internet [www.porcelaingres.com](http://www.porcelaingres.com) | tous les certifications de Porcelaingres sont disponibles sur demande et sur notre site Internet [www.porcelaingres.com](http://www.porcelaingres.com) | de Porcelaingres se pueden obtener mediante solicitud o en nuestro sitio web [www.porcelaingres.com](http://www.porcelaingres.com)

▲ according to the ISO13006 All.G (European Norms) of the B1a category and fully vitrified | nach Normvorgabe ISO13006 All.G (europäische Normen) für Feinsteinzeugfliesen der Klasse B1a | secondo la norma ISO13006 All.G (Norme europee) per piastrelle del gruppo B1a completamente vetrificate | selon la norme ISO13006 All.G (European norme) pour carreaux du groupe B1a et complètement vitrifiés | según la norma ISO 13006 An.G (normas europeas) para baldosas del grupo B1a íntegramente vitrificadas

● average value of production | mittlerer Produktionswert | valore medio di produzione | valeur moyenne de production | valor medio de producción

|   | norms<br>Normen<br>norme<br>norme<br>normas | ▲ required standards<br>▲ Normvorgabe<br>▲ valore prescritto dalle norme<br>▲ valeur prescrite par les normes<br>▲ valor establecido por las normas  | quartz stone, mile stone,<br>urban, in_wood<br><br>porcelaingres  |
|--|---|--|---|
|  <b>water absorption</b><br>Wasseraufnahme<br>assorbimento d'acqua<br>absorption d'eau<br>absorción de agua   | <b>ISO 10545.3</b>                          | $\leq 0,5\%$   | $\leq 0,05\%$   |
|  <b>sizes</b><br>Abmessungen<br>dimensioni<br>dimensions<br>dimensiones   | <b>ISO 10545.2</b>                          | length and width   Länge und Breite   lunghezza e larghezza   longueur et largeur   longitud y anchura<br>thickness   Stärke   spessore   épaisseur   espesor<br>linearity   Kanten-Linearität   rettilineità spigoli   rectitude des arêtes   rectitud de los lados<br>wedging   Rechtwinklichkeit   ortogonalità   orthogonalité   ortogonalidad<br>warpage   Ebenflächigkeit   planarità   planéité   planitud  | $\pm 0,6\%$ max<br>$\pm 5,0\%$ max<br>$\pm 0,5\%$ max<br>$\pm 0,6\%$ max<br>$\pm 0,5\%$ max   |
|  <b>bending strength</b><br>Biegefestigkeit<br>resistenza alla flessione<br>résistance à la flexion<br>resistencia a la flexión   | <b>ISO 10545.4</b>                          | $\geq 35 \text{ N/mm}^2$   | $\geq 35 \text{ N/mm}^2$  |
|  <b>resistance to deep abrasion</b><br>Widerstand gegen Tiefenverschleiß<br>resistenza all'abrasione profonda<br>résistance à l'abrasion profonde<br>resistencia a la abrasión profunda   | <b>ISO 10545.6</b>                          | $\leq 175 \text{ N/mm}^3$  | $140 \text{ mm}^3$  |
|  <b>thermal expansion coefficient</b><br>Wärmeausdehnungskoeffizient<br>coefficiente di dilatazione termica lineare<br>coefficient de dilatation thermique linéaire<br>coeficiente de dilatación térmica lineal   | <b>ISO 10545.8</b>                          | testing method available<br>verfügbares Prüfverfahren<br>metodo di prova disponibile<br>méthode d'essai disponible<br>método de ensayo disponible  | $7 \text{ MK}^{-1}$   |
|  <b>thermal shock resistance</b><br>Temperaturwechselbeständigkeit<br>resistenza agli sbalzi termici<br>résistance aux écarts de température<br>resistencia al choque térmico  | <b>ISO 10545.9</b>                          | testing method available<br>verfügbares Prüfverfahren<br>metodo di prova disponibile<br>méthode d'essai disponible<br>método de ensayo disponible  | resistant<br>widerstandsfähig<br>resistenti<br>résistants<br>resistentes  |
|  <b>frost resistance</b><br>Frostbeständigkeit<br>resistenza al gelo<br>résistance au gel<br>resistencia a la helada  | <b>ISO 10545.12</b>                         | no sample must show alterations to surface<br>die Muster sollen weder Bruch noch Schäden an der Oberfläche aufweisen<br>nessun campione deve presentare rotture o alterazioni apprezzabili della superficie<br>aucun échantillon ne doit présenter de ruptures ou d'altérations considérables de la surface<br>las muestras no deben presentar roturas o alteraciones apreciables de la superficie   | frost resistance<br>frostbeständig<br>non gelivi<br>non gélifs<br>resistentes a la helada   |
|  <b>chemical resistance</b><br>Beständigkeit gegen Chemikalien<br>resistenza all'attacco chimico<br>résistance à l'attaque chimique<br>resistencia a la agresión química  | <b>ISO 10545.13</b>                         | no sample must show visible signs of chemical attack (acids-bases-additives for pools) except for products containing hydrofluoric acid and derivatives.<br>die Muster dürfen keine sichtbaren Spuren infolge chemischer Einwirkung zeigen (Säuren-Basen-Zusatzstoffe für Schwimmbecken) mit Ausnahme der Produkte, die Fluorwasserstoff und dessen Nebenerzeugnisse enthalten.<br>nessun campione deve presentare alterazioni visibili all'attacco chimico (acidi-basi-sali da piscina) ad esclusione di prodotti contenenti acido fluoridrico e suoi composti.<br>aucun échantillon ne doit présenter d'altérations visibles d'attaque chimique (acides-bases-additifs pour piscine) sauf les produits qui sont composés avec de l'acide fluorhydrique et ses dérivés.<br>las muestras no deben presentar alteraciones visibles por la agresión química (ácidos, bases y sales de piscina) a excepción de los productos que contengan ácido fluorhídrico y sus compuestos. | unaffected<br>nicht angegriffen<br>non attaccati<br>non attaqués<br>resistentes a los agentes químicos  |
|  <b>stain resistance</b><br>Fleckenbeständigkeit<br>resistenza alle macchie<br>résistants aux taches<br>resistencia a las manchas   | <b>ISO 10545.14</b>                         | unglasierte tiles: testing method available<br>unglasierte Fliesen: verfügbares Prüfverfahren<br>piastrelle non smaltate: metodo di prova disponibile<br>arreaux non-émaillés: méthode d'essai disponible<br>baldosas no esmaltadas: método de ensayo disponible   | class 5<br>Klasse 5<br>classe 5<br>classe 5<br>classe 5   |
|  <b>colour resistance to light</b><br>Lichtbeständigkeit<br>resistenza dei colori alla luce<br>résistance des couleurs à la lumière<br>resistencia de los colores a la luz  | <b>DIN 51094</b>                            | no sample must show noticeable colour change<br>kein Exemplar soll sichtbare Farbveränderungen aufweisen<br>nessun campione deve presentare apprezzabili variazioni di colore<br>arreaux non-émaillés: méthode d'essai disponible<br>ninguna muestra debe presentar variaciones de color apreciables   | no change in brightness or colour<br>Glanz und Farbe der Muster unverändert<br>campioni inalterati in brillantezza e colore<br>échantillons inchangés en brillance et couleur<br>muestras con brillo y color inalterado |
|  <b>brightness (polished)</b><br>Glanz (geschliffen)<br>brillantezza (levigati)<br>brillant (polis)<br>brillantez (pulidos)   |   |  | -   |
|  <b>skid resistance average coefficient on friction (μ)</b><br>Rutschhemmende Eigenschaft mittlerer Reibungswert (μ)<br>scivolosità coefficiente di attrito medio (μ)<br>nature glissante coefficient de frottement moyen (μ)<br>antideslizante coeficiente de fricción media (μ) | <b>DIN 51130</b><br><br><b>DIN 51097</b>    |  | <b>20mm R11 UGL</b><br><b>6 mm R10 UGL</b><br><br><b>20mm A+B</b><br><b>6 mm A</b>  |



Farbdruckwiedergabe und Dekore Unverbindlich. Alle Rechte sind vorbehalten. Der vollständige oder auszugsweise Nachdruck des Inhalts dieses Kataloges in Schrift und Bild ist verboten und wird nach Maßgabe des Gesetzes geahndet. Die in den Tabellen enthaltenen Daten in Bezug auf den Inhalt pro Karton und das Gewicht der jeweiligen Verpackung sind zum Ausgabedatum richtiggestellt worden. Jeweilige Veränderungen entsprechender Daten sind somit vorbehalten.

colors and decors reproductions are approximate. All rights are reserved. Total or partial reproduction of text or illustrations of this catalogue is prohibited and is subject to legal sanctions. The tables with the data referred to the content per box and to the packing weight are update at the catalogue printing time; therefore the listed data can be altered.

reproduction de couleurs and décorations sont approximative. Tous les droits sont réservés. Toute reproductions totale ou partielle du contenu - textes et images - du présent catalogue est interdite et constituerait une contrefaçon sanctionnée par la loi. Les tables avec les données concernant les contenus par colis et les poids des emballage sont ajournés au moment où le catalogue est imprimé, c'est pourquoi les données peuvent subir des variations.

la riproduzione di colori e decori è approssimativa. Tutti i diritti sono riservati. Ogni riproduzione totale o parziale dei contenuti del presente catalogo, sia di testo che di immagine, è vietata e sarà perseguita in termini di legge. Le tabelle con i dati riferiti ai contenuti per scatole ed ai pesi degli imballi sono aggiornate al momento della stampa del catalogo, pertanto i dati elencati possono subire variazioni.

la reproducción de los colores y las decoraciones es indicativa. Todos los derechos están reservados. La reproducción total o parcial de los contenidos del presente catálogo, textos o imágenes, está prohibida y será perseguida con arreglo a la ley. Las tablas con los datos relativos a los contenidos para cajas y a los pesos de los embalajes corresponden al momento en el que se imprime el catálogo, por lo que los datos indicados pueden sufrir variaciones.





Porcelaingres GmbH  
Irisstraße 1  
03226 Vetschau – Deutschland  
Tel +49 (0)35433 / 597 0  
Fax +49 (0)35433 / 597-170

Berlin Showroom  
Mehringdamm 55  
10691 Berlin - Deutschland  
Tel +49(0)30 / 616 753 017

Castellarano Showroom  
Via Guido Reni 2  
42014 Castellarano (RE) - Italy  
Tel +39 0536 / 857536

[www.porcelaingres.com](http://www.porcelaingres.com)  
[info@porcelaingres.com](mailto:info@porcelaingres.com)